

Service  
Service  
**Service**

# Service Manual

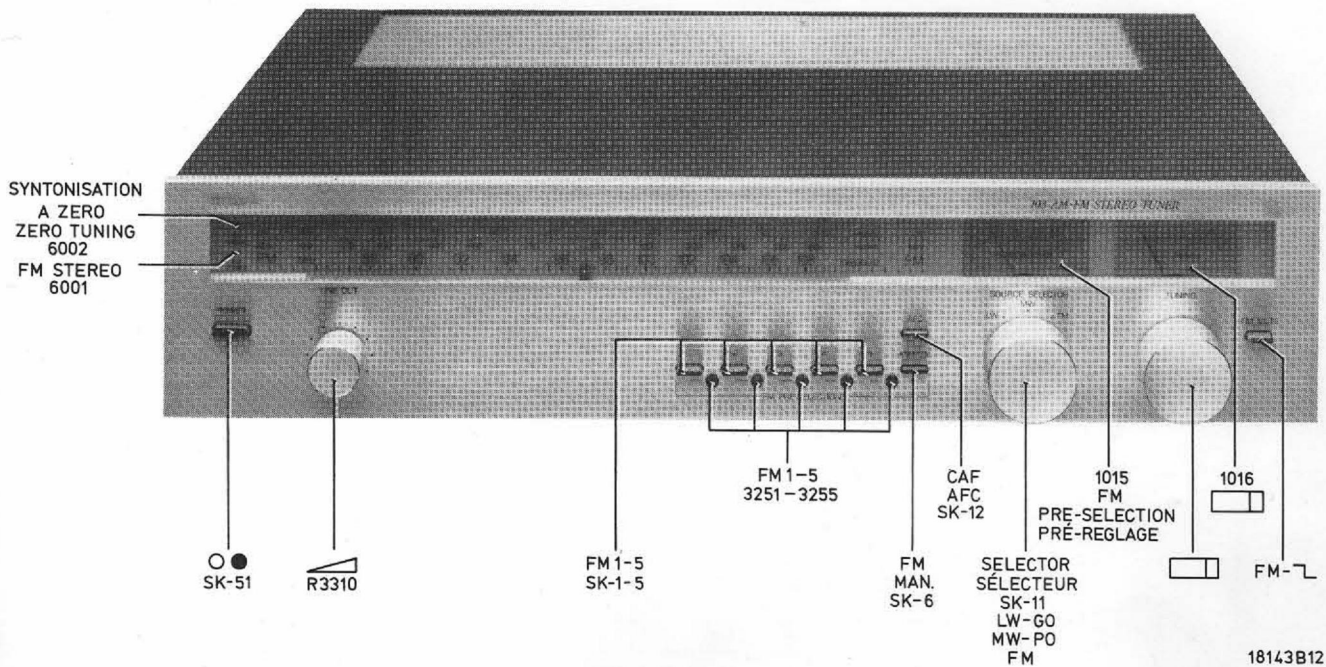

Documentation Technique Service Dokumentation Documentazione di Servizio Huolto-Ohje Manual de Servicio Manual de Servicio



Subject to modification  
4822 725 13287  
Printed in The Netherlands

**PHILIPS**

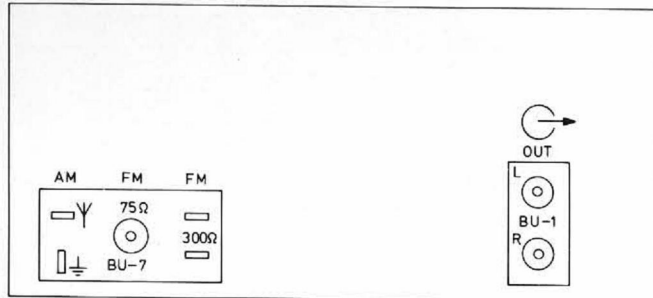

18177A2

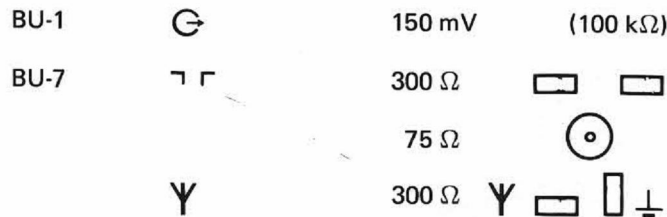

PO-MW	517 - 1622 kHz	IF-AM	/00/15	468 kHz
GO-LW	148,5 - 347 kHz		/12/28/29	452 kHz
FM	87,2 - 108,5 MHz	IF-FM		10,7 MHz

(GB)

For more detailed technical specifications please consult commercial Dokumentation

(F)

Pour l'obtention de données techniques plus détaillées veuillez consulter la Documentation commerciale

(I)

In modo da ottenere dati tecnici più particolareggiati, vi preghiamo di riferirvi alla Documentazione commerciale

(NL)

Voor meer uitgebreide technische specificaties gelieve de commerciële Documentatie te raadplegen

(D)

Für eine mehr detaillierte technische Spezifikation verweisen wir auf die kommerzielle Dokumentation.

(S)

För mera detaljerade tekniska data se kommersiell Dokumentation

(DK)

For mere detaljerede specifikationer, se tekniske datablade.

(GB)

Safety regulations require that the set be restored to its original condition and that parts which are identical with those specified, be used.

(NL)

Veiligheidsbepalingen vereisen, dat het apparaat bij reparatie in zijn oorspronkelijke toestand wordt teruggebracht en dat onderdelen, identiek aan de gespecificeerde, worden toegepast.

(F)

Les normes de sécurité exigent que l'appareil soit remis à l'état d'origine et que soient utilisés les pièces de rechange identiques à celles spécifiées.

(D)

Bei jeder Reparatur sind die geltenden Sicherheitsvorschriften zu beachten. Der Originalzustand des Geräts darf nicht verändert werden; für Reparaturen sind Original-Ersatzteile zu verwenden.

(I)

Le norme di sicurezza esigono che l'apparecchio venga rimesso nelle condizioni originali e che siano utilizzati i pezzi di ricambio identici a quelli specificati.

(S)

Säkerhetsbestämmelserna kräver att varje reparation skall utföras korrekt med hänsyn till ursprunglig placering av komponenter, ledningar etc. och med användning av föreskrivna reservdelar.

(DK)

Myndighedernes sikkerheds- og radiostøjbestemmelser kræver, at enhver reparation skal udføres korrekt m.h.t. overholdelse af originalplacering og montering af komponenter, ledningsbundter, etc. og ved anvendelse af de foreskrevne reservedele.

M	6104	6105	6106	6101,6129,6108,6252,6251,6107	6102,6103	6118	6109	6112	6110,6122,6123,1015	6111	6131	1016,6124 - 6127,6133	6116,6117,6114		
S	5101	5102	5103,5117,5118	5104	5105	5108,5119,5124	5106	5107,5120 - 5123	5109	5111	5110	5112	5113	5125	
C	2001-2170	2102	2052,2103,2113,2104	2106,2107,2101,2109	2108,2051,2110	2112,2120,2114-2118,2122,2111,2123,2144,2124,2129	2125,2127,2126	2130,2141	2134	2131-2133,2136 - 2140	2170,2169	2152,2149	2171	2172	
C	2171-2511	2185	2197	2182	2193	2196	2194	2195,2186	2190,2191,2192,2198-2202	2180	2188	2203	2205,2206	2171	2172
R	3001-3204	3101-3103,3111,3112,3108,3104,3200,3110,3105-3107,3109,3113-3116,3051,3152	3118-3124	3131,3130,3147-3151	3125 - 3128	3143	3135	3129	3132 - 3134	3136 - 3141,3183,3164 - 3169,3145,3170	3158 - 3163	3222,3223,3226 - 3229,3230	3225	3222,3223,3226 - 3229,3230	
R	3205-3525	3215,3251 + 3256	3237 - 3264	3236,3219 - 3221,3200											

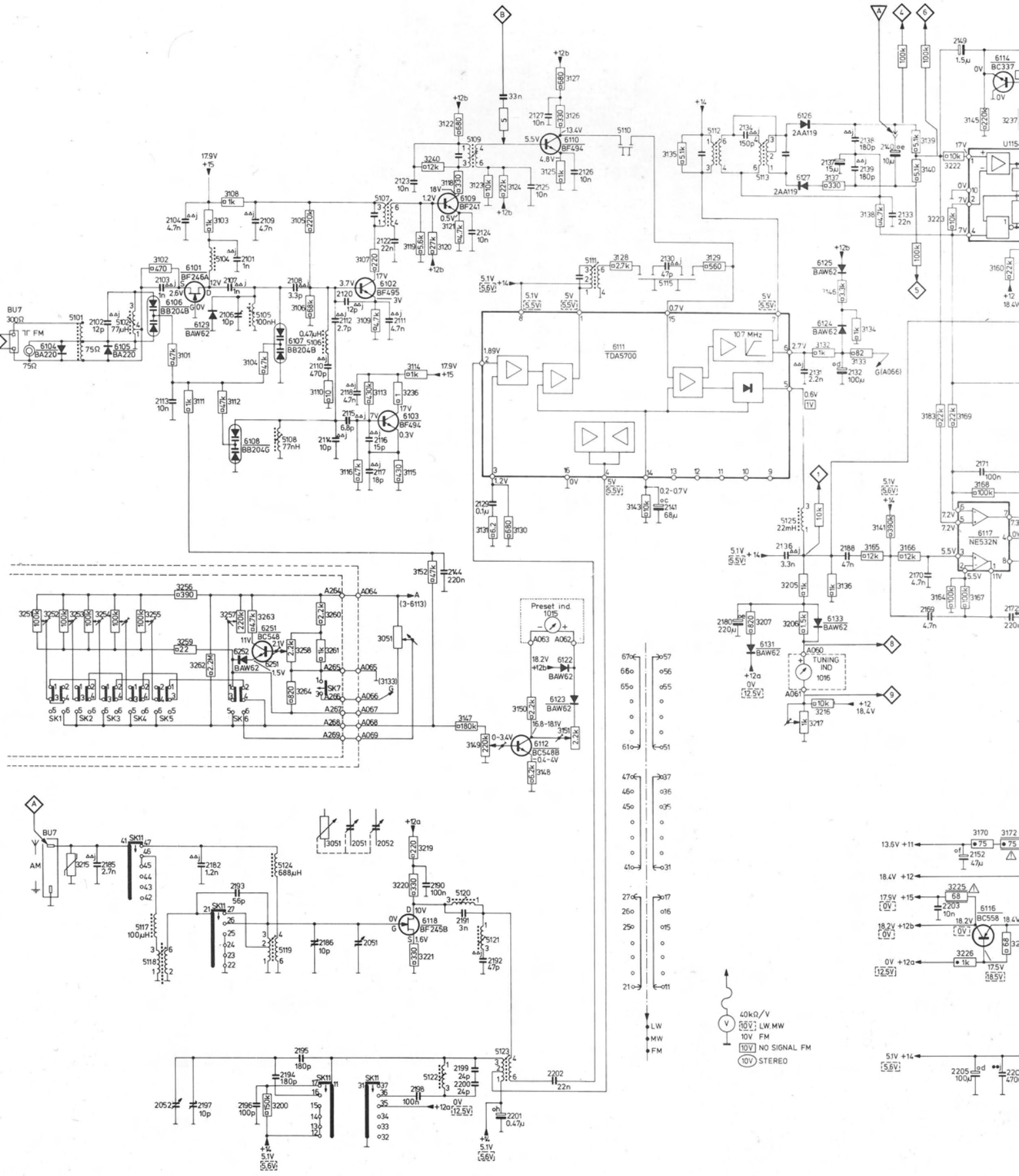

24 = 6127,6133	6116,6117,6114, 1150	6136 6002 6115,6305,6306,6113	6001 1151,6128,6301+6304	1013 1012 1011 1010
		5114		5001
2133,2136 - 2140	2170,2169 2152,2149	2150	2146 + 2148,2153 - 2156,2151 2142,2143,2145,2157 - 2160	
2188	2203 2205,2206 2171 2272	2302	2301 2309 2307 2308	2304,2305
3134	3136 = 3141,3183,3164 = 3169,3145,3170 3158 = 3160,3172	3161 = 3163,3157 3171,3179	3180 3155 3156,3182,3153,3181,3173,3174,3177,3178	
616	3225 3222,3223,3226 + 3229,3237,3208	3238 3306,3303,3304	3239 3301,3302	3307-3309 3310 3233,3234 3211,3212

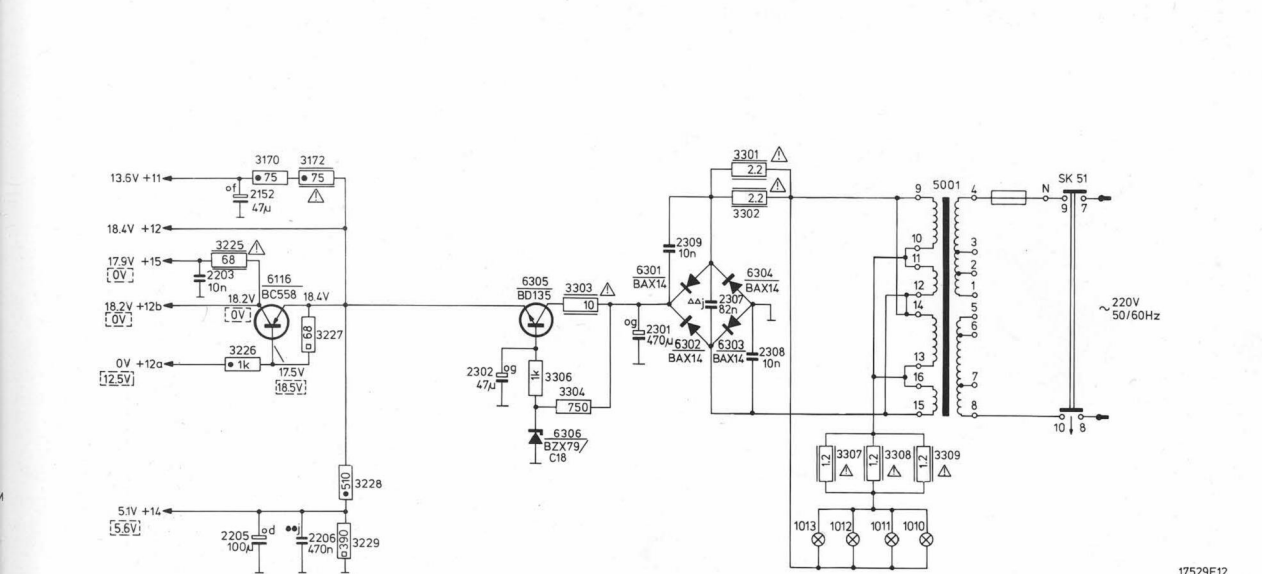
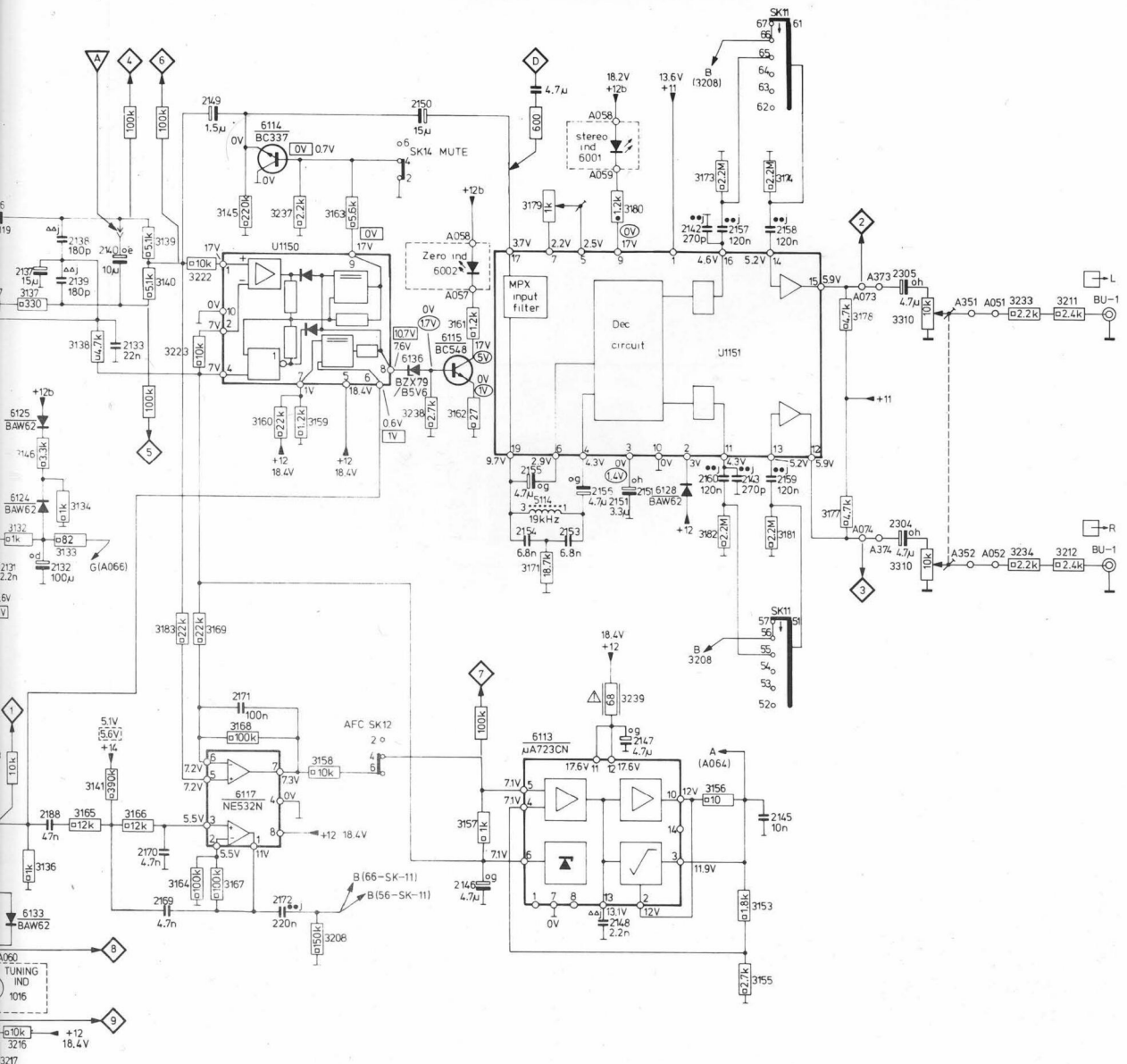



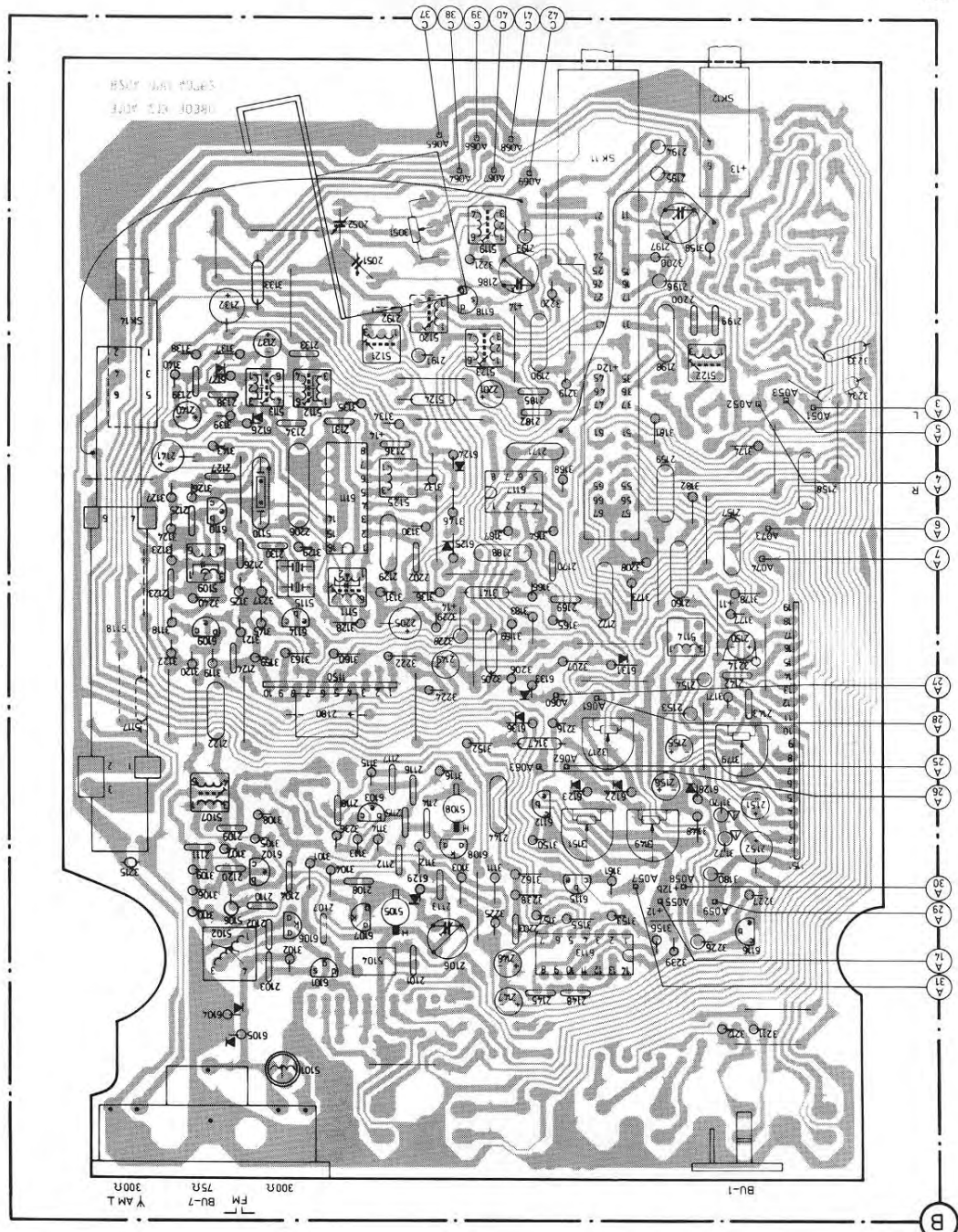
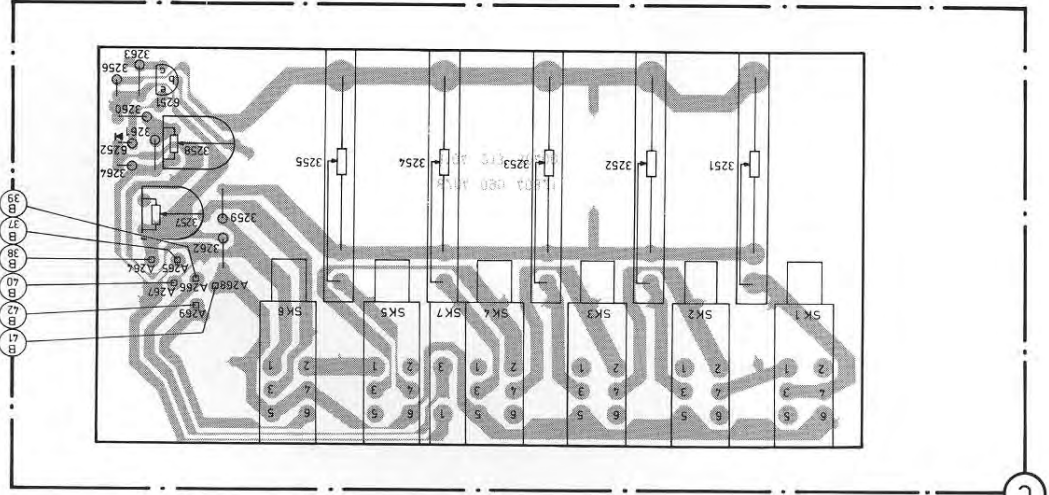

MISC	S	C	C	R	R	R	R
3263							
3264							
3265							
3266							
3267							
3268							
3269							
3270							
3271							
3272							
3273							
3274							
3275							
3276							
3277							
3278							
3279							
3280							
3281							
3282							
3283							
3284							
3285							
3286							
3287							
3288							
3289							
3290							
3291							
3292							
3293							
3294							
3295							
3296							
3297							
3298							
3299							
3300							
3301							
3302							
3303							
3304							
3305							
3306							
3307							
3308							
3309							
3310							
3311							
3312							
3313							
3314							
3315							
3316							
3317							
3318							
3319							
3320							
3321							
3322							
3323							
3324							
3325							
3326							
3327							
3328							
3329							
3330							
3331							
3332							
3333							
3334							
3335							
3336							
3337							
3338							
3339							
3340							
3341							
3342							
3343							
3344							
3345							
3346							
3347							
3348							
3349							
3350							
3351							
3352							
3353							
3354							
3355							
3356							
3357							
3358							
3359							
3360							
3361							
3362							
3363							
3364							
3365							
3366							
3367							
3368							
3369							
3370							
3371							
3372							
3373							
3374							
3375							
3376							
3377							
3378							
3379							
3380							
3381							
3382							
3383							
3384							
3385							
3386							
3387							
3388							
3389							
3390							
3391							
3392							
3393							
3394							
3395							
3396							
3397							
3398							
3399							
3400							
3401							
3402							
3403							
3404							
3405							
3406							
3407							
3408							
3409							
3410							
3411							
3412							
3413							
3414							
3415							
3416							
3417							
3418							
3419							
3420							
3421							
3422							
3423							
3424							
3425							
3426							
3427							
3428							
3429							
3430							
3431							
3432							
3433							
3434							
3435							
3436							
3437							
3438							
3439							
3440							
3441							
3442							
3443							
3444							
3445							
3446							
3447							
3448							
3449							
3450							
3451							
3452							
3453							
3454							
3455							
3456							
3457							
3458							
3459							
3460							
3461							
3462							
3463							
3464							
3465							
3466							
3467							
3468							
3469							
3470							
3471							
3472							
3473							
3474							
3475							
3476							
3477							
3478							
3479							
3480							
3481							
3482							
3483							
3484							
3485							
3486							
3487							
3488							
3489							
3490							
3491							
3492							
3493							
3494							
3495							
3496							
3497							
3498							
3499							
3500							



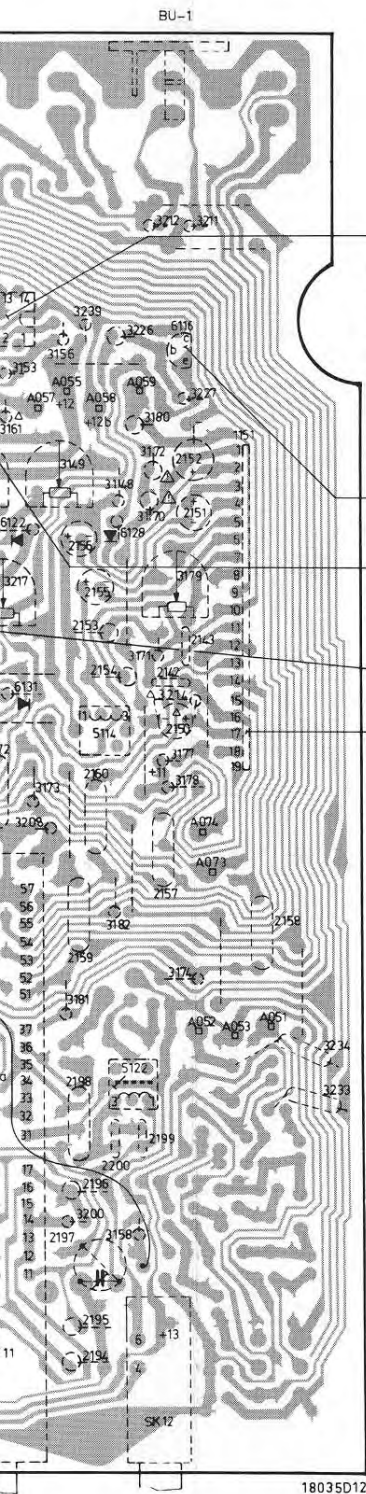

- 6113
- 1=
- 2=12V
- 3=11.9V
- 4= 7.1V
- 5= 7.1V
- 6= 7.1V
- 7= 0V
- 8=
- 9=
- 10=12V
- 11=17.6V
- 12=17.6V
- 13=13.1V
- 14=
- 6116
- e=18.4V
- b=17.5V (8.2V)
- c=18.2V (0V)
- 6115
- e=0V (1V)
- b=0V (17V)
- c=17V (5V)
- 6112
- e=
- b=
- c=
- 1151
- 1=13.6V
- 2=3V
- 3=0V (14V)
- 4=4.3V
- 5=2.5V
- 6=2.9V
- 7=2.2V
- 8=
- 9=17V (0V)
- 10=0V
- 11=4.3V
- 12=5.9V
- 13=5.2V
- 14=5.2V
- 15=5.9V
- 16=4.6V
- 17=3.7V
- 18=
- 19=9.7V

- 7
- 1V
- 3.5V
- 3.5V
- 0V
- 7.2V
- 7.2V
- 7.3V
- 8.4V

18035D12

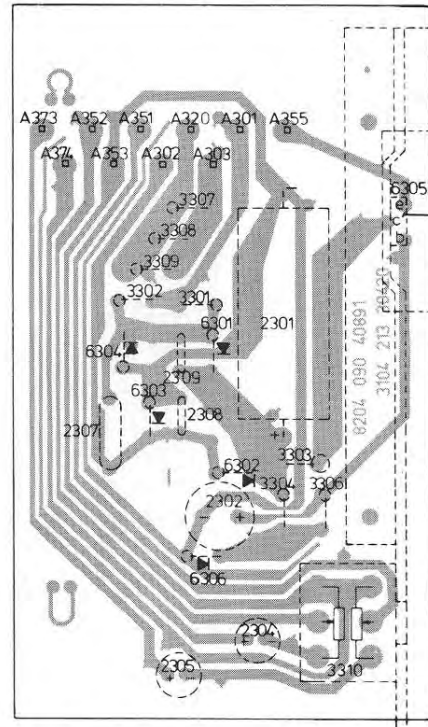

- 6305
- e= 18.4V
- b= 19 V
- c= 25 V

17554A12

MISC	6252	6251	SK6	SK5	SK7	SK4	SK3	SK2	SK1
R	3256	3264	3255	3254	3253	3252	3251		

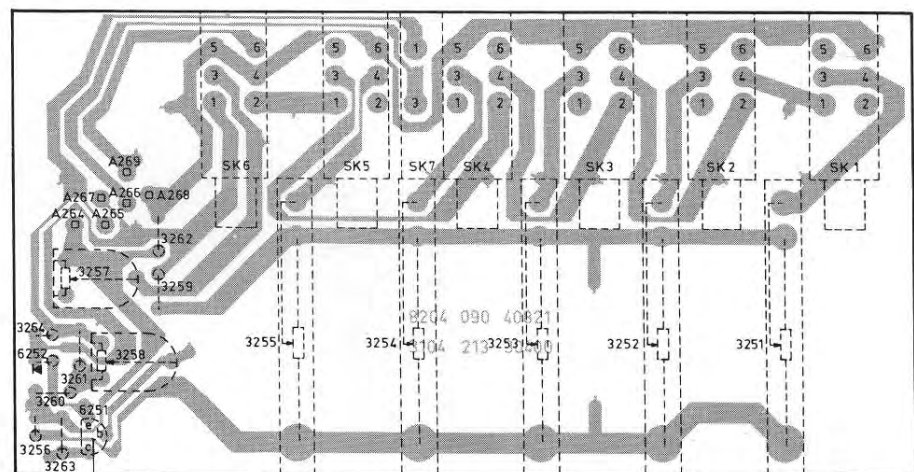

- 6251
- e=1.5V
- b=2.1V
- c=11V

17214B12



21	3	51	61
	31	32	
47			
48		12	
03		11	
01			
46	02	56	
06		39	
02	2203	25	
10		55	
13		53	
08		61	
04		62	
20		79	
12	52	09	
11		05	
09		12	
15		48	
14		51	
18		49	
16		75	
17		16	
44		79	
55		52	
43		17	
22		16	
53		36	
80		71	
42		24	
24		06	
49		05	
50		07	
22		22	
22		22	
45		28	
69		28	
72		29	
31		40	
36		83	
41		77	
25		65	
23		69	
29		78	
26		73	
30		29	
24		30	
23		67	
26		84	
25		46	
57		82	
2206		27	
58		32	
59		68	
27		74	
41		74	
36		81	
31		34	
34		39	
40		35	
2201		81	
38		90	
39		40	
90		38	
33		37	
2200		20	
92		21	
99		00	
32		18	
67		20	
96		33	
86		21	
93		58	
97		19	
95			
94			
21	31	32	61

- 6101  
g=0V  
d=12V  
s=2.6V
- 6102  
e=3V  
b=3.7V  
c=17V
- 6103  
e=17V  
b=1V  
c=0.3V
- 1150
- 1=7V  
2=7V  
3=  
4=7V  
5=18.4V  
6=0.6V [OV]  
7=1V  
8=7.6V [0.7V]  
9=17V [OV]  
10=0V
- 6109  
e=0.5V  
b=1.2V  
c=18V
- 6110  
e=4.8V  
b=5.5V  
c=13.4V
- 6114  
e=0V  
b=[OV]0.7V  
c=0V
- 6111  
1=5V [5.5V]  
2=1.9V  
3=1.2V  
4=5V [5.5V]  
5=0.6V [1V]  
6=2.7V  
7=5V [5.5V]  
8=5V [5.5V]  
9=13=  
14=0.2-0.7V  
15=0.7V  
16=0V

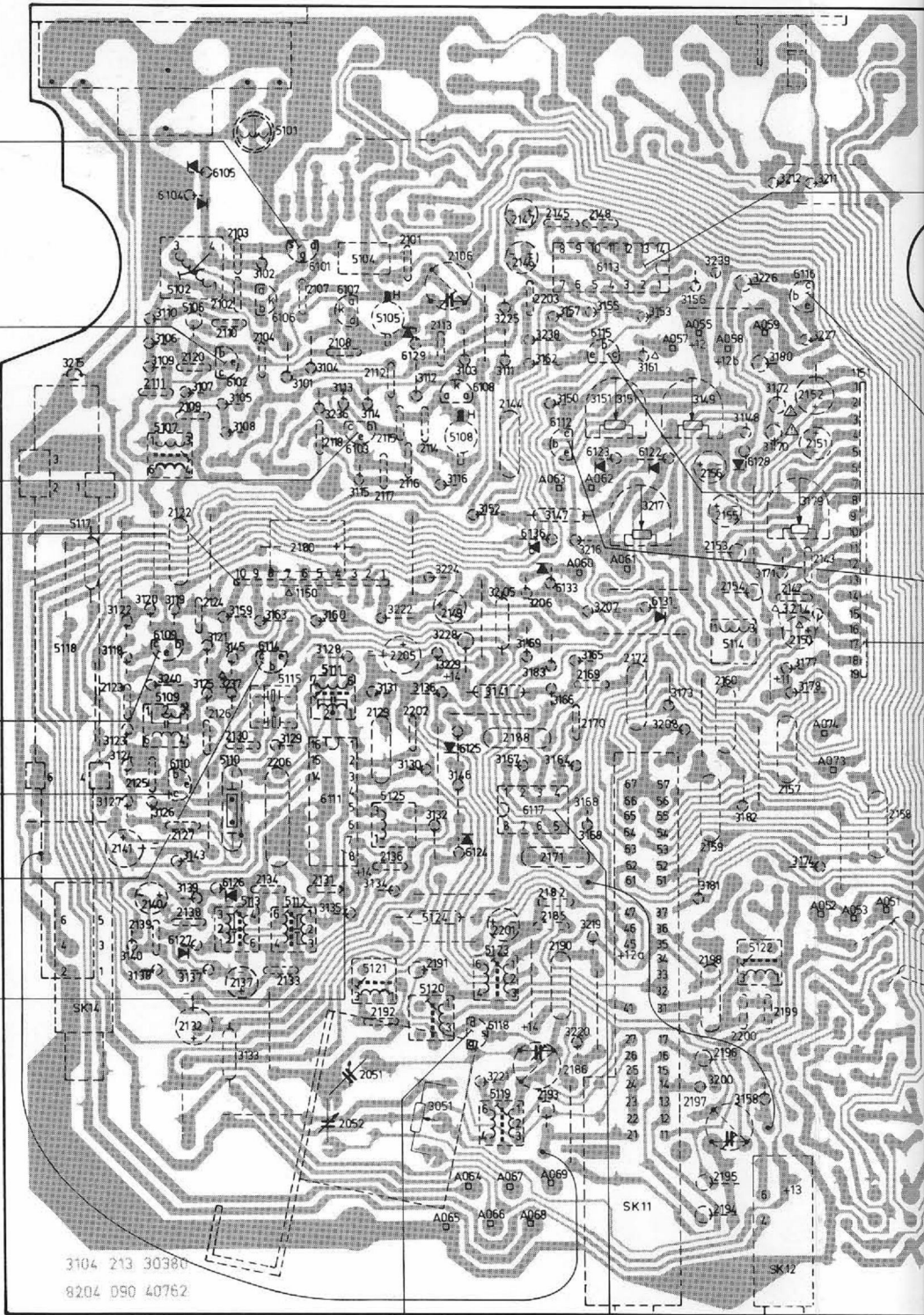

3104 213 30380  
8204 D90 40762

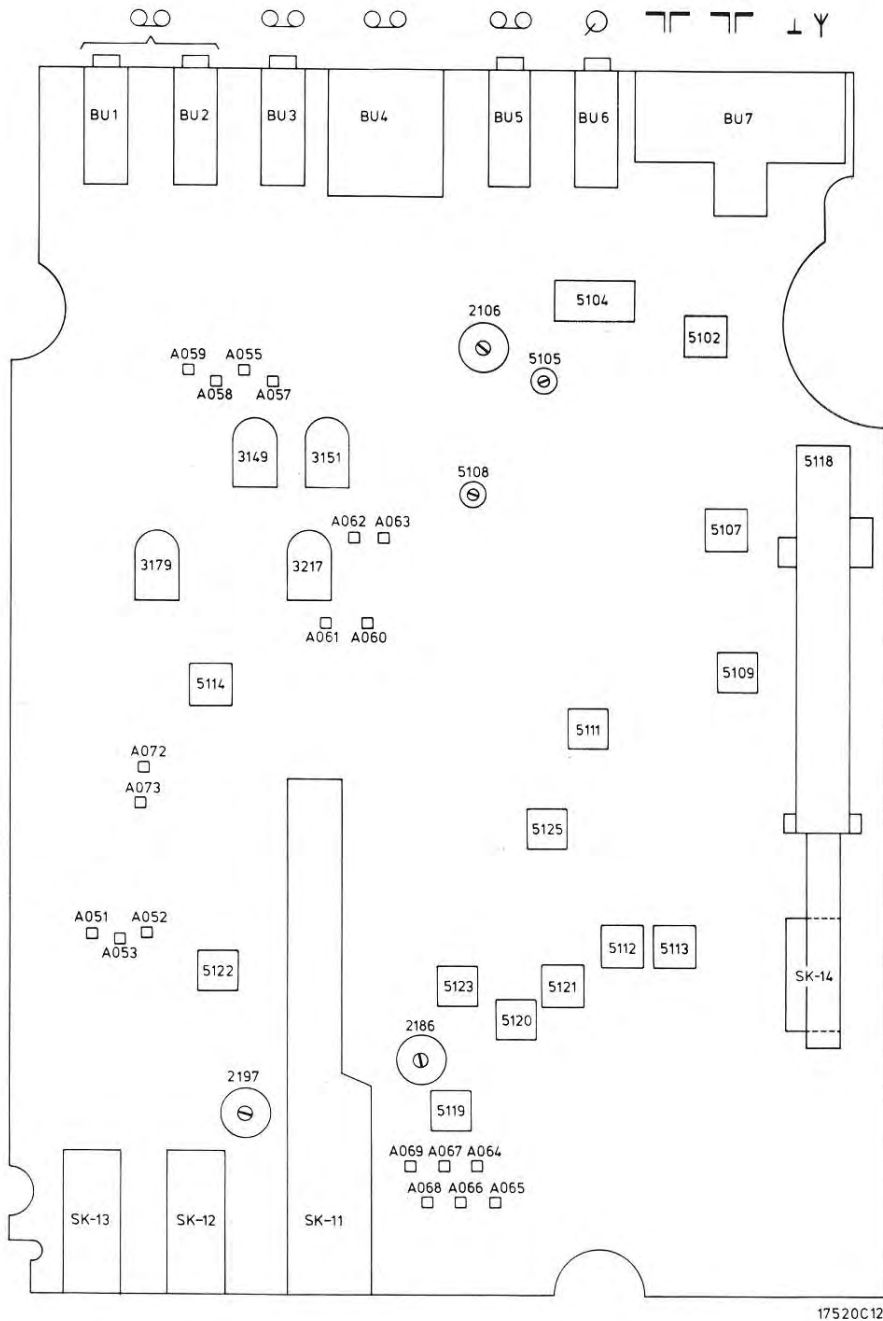

- 6118  
g=0V  
d=1.6V  
s=10V

- 6117  
1=11V  
2=5.5V  
3=5.5V  
4=0V  
5=7.2V  
6=7.2V  
7=7.3V  
8=18.4V





Alignement Réglage
AM-IF AM-FI
AM-OSC
AM-RF
FM-IF



**GB**

- 1 Before proceeding to trimming, short-circuit point 14 of IC 6111 by connecting it to the mass.
- 2 Switch off the AFC (automatic frequency control).  
Interrupt solder bridge  .  
Adjust the R.F. generator in such a way that a symmetrical response curve is obtained on the screen (= fo 5110).
- 3 The input signal shall be as low as possible.
- 4 Adjust for maximum linearity of the S-curve.
- 5 Close solder bridge  .
- 6 Adjust for zero-axis crossing (red LED shall burn glaringly).
- 7 Mark at scale.
- 8 Meter deflection  $\geq 8$  divisions.
- 9 Eliminate short-circuit at point 14 of IC 6111.

**NL**

- 1 Vóór het trimmen punt 14 IC 6111 kortsluiten met massa.
- 2 AFC uitschakelen.  
Soldeer brug  open  
RF generator zo instellen dat de doorlaatkromme symmetrisch in beeld komt (= fo 5110).
- 3 Ingangssignaal zo laag mogelijk houden.
- 4 Afregelen op max. lineariteit van de S-kromme.
- 5 Sluit brug  .
- 6 Afregelen op 0-doorgang (Rode LED moet fel branden).
- 7 Merkpunt op schaal.
- 8 Meteruitslag  $\geq 8$  schaaldelen.
- 9 Kortsluiting punt 14 IC 6111 opheffen.

**F**

- 1 Avant de procéder à l'alignement, relier le point du CI 6111 à la masse.
- 2 Mettre hors circuit la C.A.F. (commande automatique de fréquence).  
Interrompre le pont de soudure  .  
Régler le générateur RF de façon que la courbe réponse obtenue sur l'écran soit symétrique (= fo 5110).
- 3 Le signal d'entrée sera aussi bas que possible.
4. Ajuster de manière à obtenir une linéarité maximale de la courbe en S.
- 5 Fermer le pont  .
- 6 Ajuster au passage par zéro (la diode LED rouge doit s'allumer vivement).
- 7 Repère sur le cadran.
- 8 Déviation de l'appareil de mesure  $\geq 8$  divisions de l'échelle.
- 9 Eliminer le court-circuit du point 14 du CI 6111.

Alignement Réglage	SK...			 2051 2052 3051					
AM-IF AM-FI	MW	1 452 kHz 468 kHz 470 kHz (=fo 5115) (+ 1 kHz)	A	Min. cap.	5111 5121 5120		1 Max. + symm. (=fo 5115)		
		fo 5115					5111		1 Min. + symm.
AM-OSC	LW	147 kHz (+ 1 kHz)	A	Max. cap				2 or 3 Max.	
	MW	512 kHz (+ 1 kHz)							5123
		1635 kHz (+ 1 kHz)		Min. cap					2197
AM-RF	MW	600 kHz (+ 1 kHz)	A					2 or 3 Max.	
	LW	155 kHz (+ 1 kHz)							5118
	MW	1500 kHz (+ 1 kHz)							5119 2186
FM-IF	FM	2 ± 10.7 MHz Δf 250 kHz (50 Hz)	B	Min. cap.	5107 5109 5113	5112	4 + 5 Max. + symm.		
		± 10.7 MHz	C						5107 5109 3

procéder à l'alignement, relier le point 14 à la masse.

circuit la C.A.F. (commande automatique).

le pont de soudure A.

générateur RF de façon que la courbe de l'écran soit symétrique

entrée sera aussi bas que possible.

manière à obtenir une linéarité de la courbe en S.

ont A.

passage par zéro (la diode LED rouge s'allume vivement).

le cadran.

de l'appareil de mesure ≥ 8 divisions

court-circuit du point 14 du CI 6111.

D

- 1 Vor dem Abgleich ist Punkt 14 von IC 6111 gegen Masse kurzzuschliessen.
- 2 AFC ausschalten.  
Lötbrücke A öffnen.  
Hf-Generator dahin einstellen, dass die Durchlasskurve symmetrisch ins Bild kommt. (= fo von 5110).
- 3 Eingangssignal möglichst niedrig halten.
- 4 Auf Höchstlinearität der S-Kurve abgleichen.
- 5 Lötbrücke A schliessen.
- 6 Auf Nulldurchgang abgleichen (rote Leuchtdiode soll grell aufleuchten).
- 7 Marke auf Skala.
- 8 Ausschlag des Messgeräts: ≥ 8 Skalenteile.
- 9 Kurzschluss an Punkt 14 von IC 6111 beheben.

I

- 1 Prima di procedere alla taratura, cortocircuitare il punto 14 del IC 6111 collegandolo a massa.
- 2 Disinserire l'AFC (controllo automatico di frequenza).  
Interrompere il ponticello A.  
Regolare il generatore R.F. in modo che si ottenga una curva di risposta simmetrica sull'oscillatore (= fo 5110).
- 3 Il segnale d'ingresso deve essere il più basso possibile.
- 4 Regolare per la massima linearità della curva ad S.
- 5 Chiudere il ponticello A.
- 6 Regolare la curva per il passaggio sullo zero dell'ascissa (il led rosso si illuminerà al massimo).
- 7 Punto di riferimento sulla scala.
- 8 Indicazione dello strumento ≥ al punto 8.
- 9 Togliere il cortocircuito dal piedino 14 del IC 6111.



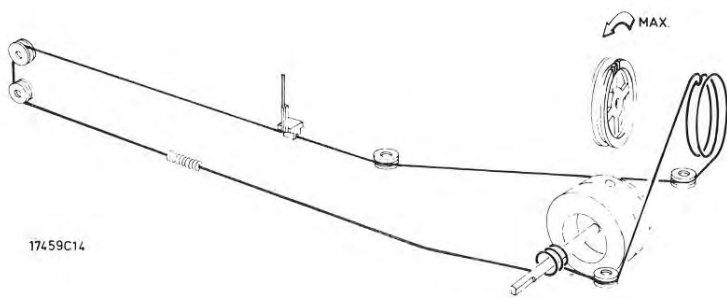

17459C14

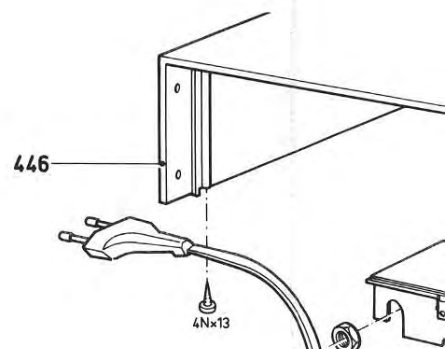

- |                 |                |
|-----------------|----------------|
| 401             | 4822 256 90265 |
| 402             | 4822 466 70357 |
| 403             | 4822 255 10151 |
| 404             | 4822 530 70123 |
| 406             | 4822 466 70356 |
| 404+406+407     | 4822 426 50366 |
| 404+406+407 /28 | 4822 426 50379 |
| 409             | 4822 413 40857 |
| 413             | 4822 413 51045 |
| 414             | 4822 413       |
| 415             | 4822 395 50133 |
| 416             | 4822 276 10579 |
| 418             | 4822 528 80186 |
| 419             | 4822 410 22231 |
| 422             | 4822 535 70457 |
| 426             | 4822 450 80629 |
| 427             | 4822 321 30215 |
| 428             | 4822 492 31495 |
| 431             | 4822 410 22228 |
| 432             | 4822 101 90086 |
| 433             | 4822 532 51099 |
| 436             | 4822 273 50187 |
| 439             | 4822 410 22229 |
| 441             | 4822 276 50258 |
| 442             | 4822 410 22227 |
| 446             | 4822 426 40162 |
| 449             | 4822 535 70457 |
| 451             | 4822 528 80186 |
| 461             | 4822 462 71121 |
| 462             | 4822 267 30318 |
| 466             | 4822 265 40145 |
| 469             | 4822 158 60427 |
| 471             | 4822 276 10692 |
| 472             | 4822 276 10692 |

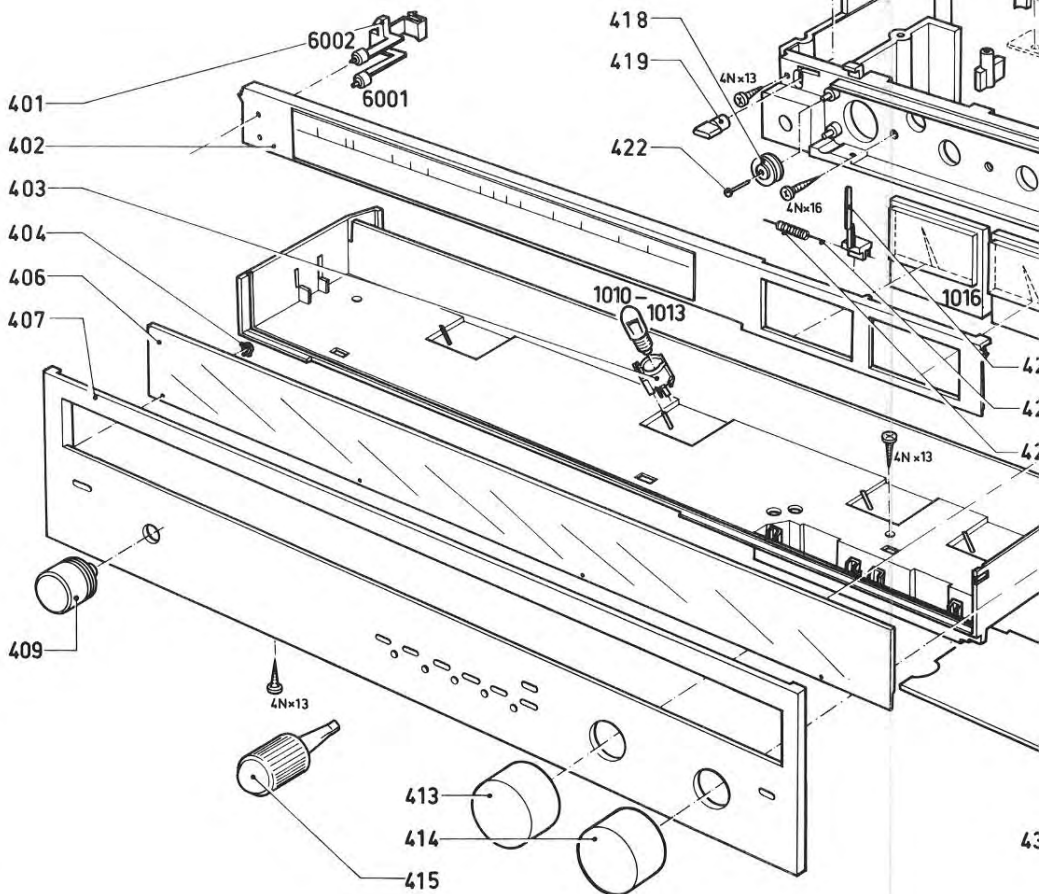



Alignement Réglage	SK...							
FM-HF	FM	109 MHz $\Delta f$ 75 kHz 1 mV		Max.		5108		
				2106		+ Max.		
				3258				
		86.8 MHz $\Delta f$ 75 kHz 1 mV		Min.		5105		+ Max.
		95.5 MHz $\Delta f$ 75 kHz 1 mV				3257		
STEREO DECODER	FM	19 kHz $\pm$ 2 Hz 100 mV				10 nF 15 16 IC6111	5114	or Min.
		100 MHz + pil. tone + R. Mod.					3179	 Min.

Stereo Decoder - Décodeur Stéréo - Decodificatore stereo - Stereodekoder

1015	FM			95.5 MHz		3149		1015 95.5
				108 MHz		3151		1015 108
1016	PU					3217		1016 0
	MW							600 kHz 10 mV





Repeat - Herhalen - Répéter - Wiederholen - Repetera - Ricominciare - Gentage - Gjentagelse - Toista

(S)

- Kortslut stift 14 på IC 6111 till jord innan trimningen påbörjas.
- AFC i läge FRÅN.  
Öppna bryggan .  
Ställ in signalgenerator så att en symmetrisk kurva erhålls på oscilloskopet (= fo 5110).
- Insignalen skall vara så låg som möjligt.
- Justera för max linjäritet på S-kurvan.
- Stäng bryggan .
- Justera för nollaxelgenomgång (röd LED skall lysa ordentligt).
- Markeringen på skalan.
- Mätarutslag  $\geq$  8 delstreck.
- Tag bort kortslutningen på stift 14 IC 6111.

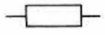
(DK)

- Inden trimningen påbegyndes, kortsluttes punkt 14 på IC 6111 til stel.
- Afbryd AFC (automatisk frevenskontrol)  
Fjern loddeforbindelsen .  
Juster generatoren således, at der opnås en symmetrisk responcekurve på skærmen (= fo 5110).
- Indgangssignalet skal holdes så lavt som muligt.
- Juster S-kurven til maximum linearitet.
- Monter atter loddeforbindelsen .
- Indjuster nulovergangen, således at den røde LED lyser.
- Sæt et mærke på skalaen.
- Meter-udslaget skal være større end, eller lig med  $\geq$  8 streger.
- Husk at fjerne kortslutningen ved punkt 14 på IC 6111.

-TS- 			-R- 		
6101	BF246A	5322 130 44798	3149	220 K	4822 100 10088
6102,6110	BF494	4822 130 44195	3151	2,2 K	4822 100 10029
6103	BF495	4822 130 40947	3172	10 K	4822 100 10035
6109	BF241	4822 130 40898	3179,3217	1 K	4822 100 10037
6112	BC548C	4822 130 44196	3215	VDR	4822 116 20073
6114	BC337	4822 130 40855	3230,3217, } 3239,3225 }	Safety 68 Ω	4822 111 30426
6115	BC548	4822 130 40938	3251-3255	100K	4822 101 90086
6116	BC558	4822 130 40941	3257	220K	4822 100 10088
6118	BF245B	4822 130 41024	3258	2K2	4822 100 10029
6251	BC548	4822 130 40938	3301,02	Safety 2,2 Ω	4822 111 30437
6309	BD135	4822 130 40645	3303	Safety 10 Ω	4822 111 30114
			3307,3308	Safety 1,2 Ω	4822 111 30384
			3310	2x10 kΩ lin.	4822 102 30317
-D- 			-C- 		
6001		4822 130 31049	2001-2002	10,000 uF - 50 V	4822 124 70319
6002		4822 130 31137	2106,2197	10 pF	4822 125 50062
6104,6105	BA220	4822 130 34221	2113,2145, } 2123,2127 }	10 nF	4822 122 30043
6106,6107	BB204b	4822 130 34449	2122	22 nF	5322 121 44204
6108	BB204g	5322 130 34825	2129,2171 } 2190,2198 }	0.1 uF	4822 121 40334
6112-6125, } 6128-6135 }	BAW62	4822 130 30613	2133,2143, } 2203,2204 }	22 nF	4822 122 30103
6126,6127	2-AA119	4822 130 30312	2137,2147	16 V - 15 μF	4822 124 20883
6136	BZX79/B5V6	4822 130 34173	2153,2154	6,8 n	4822 121 50538
6252	BAW62	4822 130 30613	2163,2164	0.47 uF - 50 V	4822 124 40239
6301-6304	BAX14	4822 130 34193	2149	1,5 uF - 50 V	4822 124 20828
6306	BZX79/C20	5322 130 34499	2186	5 pF	4822 125 50077
			2188,2189		4822 125 20219
			2191	3 nF	4822 121 50414
			2193	62 p - 1 %	4822 121 50558
			2194	160 p - 1 %	4822 121 50561
			2195	215 p - 1 %	5322 121 54075
			2196	113 p - 1 %	4822 121 50702
			2308,2309	10 nF	4822 122 30043
			-Miscellaneous-		
			1010-1013	6,3 V - 250 mA	4822 134 40007
			1015		4822 347 10228
			1016		4822 347 10229
			1150		4822 218 10122
			1151		4822 210 30029
-IC- 					
6111	TDA5700	4822 209 80358			
6113	μA723CN	5322 209 84655			
6117	NE532N	4822 209 80484			
5001		4822 146 40235			
5101	300 - 75 Ω	4822 146 30324			
5105	77 nH	4822 157 50973			
5106	0.47 μH	4822 157 50967			
5107	10.7MC	4822 153 50116			
5108	50 nH	4822 157 50895			
5109	10.7MC	4822 153 50205			
5110	10.7MC.SFJ10.7	4822 242 70287			
5111	452 KC	4822 156 20816			
5112		4822 153 50207			
5113		4822 153 50208			
5114	19 KC	4822 156 20743			
5115	452KC SF452	4822 266 20069			
5115	468 kHz SF468	4822 242 70275			
5117	100 μH	4822 157 50964			
5118		4822 158 60427			
5119	LW	4822 156 20817			
5120		4822 156 30582			
5121		4822 156 30583			
5122,5123	LW/MW	4822 156 20818			
5124	680 μH	4822 156 50968			
5125	22 mH	4822 156 20743			

---

# Service mededeling

PHILIPS NEDERLAND B.V. - EINDHOVEN  
TECHNISCHE SERVICE

---

Ref. 416 PH

Type 22 AH 103

Datum juni 1981

---

Betr.: 22 AH 103/12/28 vanaf stempel PL 05.

Bij toepassing van de TDA 5700 punt 2, dient men voor verbetering van de gevoeligheid de volgende weerstanden te wijzigen:

R 3136 wordt 3 kohm  
R 3160 wordt 27 kohm  
R 3207 wordt 1,5 kohm  
R 3159 wordt 15 kohm  
R 3224 vervalt

Voorbeeld:

TDA 5700

HSHO 142 2-puntnummer

---

A 81 - 217



**PHILIPS**